

#1213



PAUL D. PATE
Secretary of State
State of Iowa

TRANSMITTAL FORM FOR CONDEMNATION APPLICATION –
Pursuant to Iowa Code sections 6B.3(3), 9.2A, and 331.602(24)

Box 1

TRANSMITTAL FORM FOR SHERIFF'S STATEMENT –
Pursuant to Iowa Code sections 6b.38, 9.2A, and 331.602(24)

Box 2

Part I: CONDEMNATION APPLICATION

Pursuant to Iowa Code section 6B.3(3), the undersigned County Recorder files a copy of the attached Condemnation Application with the Office of the Secretary of State, noting as follows.

1. The name of the acquiring agency is Lee County
2. The real property subject to the Application is located in Lee County.
3. The date the condemnation application was filed by the undersigned County Recorder is February month, 4 day, 2015 year.
4. The attached Condemnation Application is filed of record at Document # _____
Book 2015, Page 436.

Nancy L. Bostange
County Recorder for

Lee County

Part II: SHERIFF'S STATEMENT

Pursuant to Iowa Code section 6B.38, the undersigned County Recorder files a copy of the attached Sheriff's Statement with the Office of the Secretary of State, noting as follows.

1. The name of the acquiring agency is _____
2. The corresponding Condemnation Application to this Sheriff's Statement was filed of record at Document # _____, Book _____, Page _____ and a copy was sent to the Secretary of State.
3. The attached Sheriff's Statement was filed of record at Document # _____
Book _____, Page _____; on _____ month, _____ day, _____ year.

County Recorder for

County

PLEASE SUBMIT TO:
Secretary of State
Attention: Condemnation Filings
State Capitol, Des Moines, IA 50319
FAX: 515-242-5952

SEE INSTRUCTIONS ON BACK

Book 2015 Page 436

Document 2015 436 Type 06 040 Pages 30
Date 2/04/2015 Time 9:59 AM
Rec Amt 5.00

NANCY L. BOOTEN, RECORDER
LEE COUNTY, IOWA

Indexed _____ Scanned _____

Index Check _____ Scan Check _____

Red Ind. C. _____ Bk. _____ Notes _____

Recorder's Note: All attached Roadway Easement Plats are partials of the plats.

Recorder's Cover Sheet

In the Matter of the Condemnation of Certain Lands in Lee County, Iowa.

RE: Project No. RC-CO56(87)9A-56

Application to the Chief Judge of the Eighth Judicial District for the Appointment of a
Commission to Assess Damages and Order Appointing Compensation Commission

Preparer Information:

Michael P. Short, Lee County Attorney, P. O. Box 824, Keokuk, Iowa 52632
319/524-9590

Return Document to:

Michael P. Short, Lee County Attorney, P. O. Box 824, Keokuk, Iowa 52632

BEFORE THE LEE COUNTY CONDEMNATION COMMISSION

IN THE MATTER OF THE
CONDEMNATION OF CERTAIN
LANDS IN LEE COUNTY, IOWA

RE: PROJECT NO. RC-CO56(87)--9A-56

APPLICATION TO THE CHIEF JUDGE OF THE EIGHTH JUDICIAL DISTRICT
FOR THE APPOINTMENT OF A COMMISSION TO ASSESS DAMAGES.

To: The Honorable Mary Ann Brown, Chief Judge, Eighth Judicial District

COMES NOW Michael P. Short as County Attorney for Lee County, State of Iowa, and the County from which funds disbursed for payment are to be paid, and states to the Chief Judge of this Judicial District as follows:

1. Lee County seeks to condemn the below described property for the purpose of a roadway construction, reconstruction, grading, widening and utility relocation within the existing pursuant to Chapter 6B, Code of Iowa, 2015. Section 6B.2A does apply to the Condon property, TRACT III. Section 6B.2A does not apply to the balance of the property. Lee County is making application for condemnation of road right-of-way that except for the Condon property described below is contiguous to an existing road right-of-way. All property is necessary for the maintenance, safety improvement, repair or upgrading of an existing roadway.
2. Pursuant to section 6B.2C the Lee County Board of Supervisors did by Resolution number 2015-52 dated January 27, 2015, approved the commencement of condemnation proceedings. There is a reasonable expectation that the applicant will be able to achieve its public purpose and comply with all applicable standards.
3. The property sought to be condemned consists of agricultural land.
4. The acquiring agency has made good faith effort to negotiate with the owner to purchase the property before filing this Application for Condemnation. A copy of Lee County's appraisal report was timely provided to each landowner. Lee County has made offers to each of the landowners at an amount above full fair market value as determined by that appraisal.

5. The name and address of the individual designated by the condemning agency to respond to questions is Ernie Steffensmeier, Lee County Engineer, 933 Avenue H, P. O. Box 158, Ft. Madison, Iowa 52627; telephone (319) 372-2541.
6. The Lee County Engineer's office has determined that the requests set out below represents the minimum amount of land necessary to safely construct the roadway.
7. The following is a description of the property in Lee County, Iowa, sought to be condemned:

TRACT I

A. A description of the property sought to be condemned:

PARCEL 5687(E)- Connie Ketchum, Diane Lange, And Danny Lange as Co-Trustees
PART OF THE SOUTHWEST QUARTER OF THE SOUTHEAST QUARTER OF SECTION 8, TOWNSHIP 68 NORTH, RANGE 3 WEST OF THE FIFTH PRINCIPAL MERIDIAN, LEE COUNTY, IOWA. BEING MORE PARTICULARLY DESCRIBED AS FOLLOWS:
BEGINNING AT THE SOUTH QUARTER CORNER OF SAID SECTION 8; THENCE N 00°45'17" W, ALONG THE WEST LINE OF THE SOUTHEAST QUARTER OF SAID SECTION 8, A DISTANCE OF 75.00 FEET; THENCE N 89°41'12" E, 1322.91 FEET TO THE EAST LINE OF THE SOUTHWEST QUARTER OF THE SOUTHEAST QUARTER OF SAID SECTION 8; THENCE S 00°47'28" E ALONG SAID EAST LINE, 75.00 FEET TO THE SOUTH LINE OF THE SOUTHWEST QUARTER OF THE SOUTHEAST QUARTER OF SAID SECTION 8; THENCE S 89°41'12" W ALONG SAID SOUTH LINE, 1322.95 FEET BACK TO THE POINT OF BEGINNING, CONTAINING 1.244 ACRES, MORE OR LESS, EXCLUSIVE OF PRESENT ESTABLISHED ROADWAY
BEING PART OF THE PARCEL AS DESCRIBED IN DOCUMENT NUMBER 2012N-3236.

B. A plat showing the right-of-way sought to be condemned with reference to the description is attached as Exhibit TRACT I E.

C. The property is agricultural.

D. The name and addresses of all record owners and lien and encumbrance owners and other parties who by law are entitled to notice regarding this tract are:

1. Owners: Danny Lange, 14464 Skunk River Road, Burlington, IA 52601; Connie Ketchum, 160 Morgan Ct. Cedar Rapids, IA 52441 and Diane Lange 3101 14th Street, Burlington, IA 52601; as Co-Trustees of the Marvin Dale Lange Testamentary Marital Trust and as Co-Trustees of the Marvin Dale Lange Family Trust, and individual, Connie Ketchum (and Spouse); Diane Lange, (and Spouse) and Danny Lange (and Spouse)

2. Mortgagee and mortgagors: None
3. Tenants: None
4. Contract vendors or vendees: None
5. Lien Holders of Record: None
6. Others entitled to notice: None

TRACT II

A. A description of the property sought to be condemned:

PARCEL 5687(F)- Connie Ketchum, Diane Lange, And Danny Lange

PART OF THE SOUTHEAST QUARTER OF THE SOUTHEAST QUARTER OF SECTION 8, TOWNSHIP 68 NORTH, RANGE 3 WEST OF THE FIFTH PRINCIPAL MERIDIAN, LEE COUNTY, IOWA. BEING MORE PARTICULARLY DESCRIBED AS FOLLOWS:

BEGINNING AT THE SOUTHEAST CORNER OF SAID SECTION 8; THENCE S 89°40'45" W, ALONG THE SOUTH LINE OF THE SOUTHEAST QUARTER OF THE SOUTHEAST QUARTER OF SAID SECTION 8, A DISTANCE OF 1322.08 FEET TO THE WEST LINE OF THE SOUTHEAST QUARTER OF THE SOUTHEAST QUARTER OF SAID SECTION 8; THENCE N 00°47'28" W ALONG SAID WEST LINE, 80.00 FEET; THENCE N 89°40'45" E, 237.46 FEET; THENCE S 00°19'15" E, 5.00 FEET; THENCE N 89°40'45" E, 1084.63 FEET TO THE EAST LINE OF THE SOUTHEAST QUARTER OF SAID SECTION 8; THENCE S 00°48'39" E ALONG SAID EAST LINE, 75.00 FEET BACK TO THE POINT OF BEGINNING, CONTAINING 1.266 ACRES, MORE OR LESS, EXCLUSIVE OF PRESENT ESTABLISHED ROADWAY. BEING PART OF THE PARCEL AS DESCRIBED IN DOCUMENT NUMBER 2012N-3236.

B. A plat showing the right-of-way sought to be condemned with reference to the description is attached as Exhibit TRACT II F.

C. The property is agricultural.

D. The name and addresses of all record owners and lien and encumbrance owners and other parties who by law are entitled to notice regarding this tract are:

1. i. Owners: Danny Lange, 14464 Skunk River Road, Burlington, IA 52601; Connie Ketchum, 160 Morgan Ct. Cedar Rapids, IA 52441 and Diane Lange 3101 14th Street, Burlington, IA 52601; as Co-Trustees of the Marvin Dale Lange Testamentary Marital Trust and as Co-Trustees of the Marvin Dale Lange Family Trust, and individual, Connie Ketchum (and Spouse); Diane Lange, (and Spouse) and Danny Lange (and Spouse)

2. Mortgagee and mortgagors: None

3. Tenants: None
4. Contract vendors or vendees: None
5. Lien Holders of Record: None
6. Others entitled to notice: None

TRACT III

A. A description of the property sought to be condemned:

PARCEL 5687(H)- Larry L. Congdon and Kathleen G. Congdon as Co-Trustees
PART OF THE NORTHEAST QUARTER OF THE SOUTHEAST QUARTER OF SECTION 17, TOWNSHIP 68 NORTH, RANGE 3 WEST OF THE FIFTH PRINCIPAL MERIDIAN, LEE COUNTY, IOWA. BEING MORE PARTICULARLY DESCRIBED AS FOLLOWS:
BEGINNING AT THE EAST QUARTER CORNER OF SAID SECTION 17; THENCE S 00°55'45" E, ALONG THE EAST LINE OF THE SOUTHEAST QUARTER OF SAID SECTION 17, A DISTANCE OF 1336.20 FEET TO THE SOUTH LINE OF THE NORTHEAST QUARTER OF THE SOUTHEAST QUARTER OF SAID SECTION 17; THENCE S 89°30'40" W ALONG SAID SOUTH LINE, 142.54 FEET; THENCE N 01°15'07" W, 81.53 FEET; THENCE ALONG A CURVE TO THE RIGHT WHOSE RADIUS EQUALS 22,998.00 FEET, AN ARC LENGTH OF 316.15 FEET, WITH A LONG CHORD BEARING N 00°51'30"W, 316.15 FEET; THENCE N 00°27'52" W, 938.66 FEET TO THE NORTH LINE OF THE SOUTHEAST QUARTER OF SAID SECTION 17; THENCE N 89°34'51" E, ALONG SAID NORTH LINE, 135.00 FEET TO THE POINT OF BEGINNING. CONTAINING 4.297 ACRES.
BEING PART OF THE PARCEL AS DESCRIBED IN DOCUMENT NUMBER 94N 82 A1.

B. A plat showing the right-of-way sought to be condemned with reference to the description is attached as Exhibit TRACT III H.

C. The property is agricultural.

D. The name and addresses of all record owners and lien and encumbrance owners and other parties who by law are entitled to notice regarding this tract are:

1. Owners: Larry L. Congdon and Kathleen G. Congdon, Co-Trustees of the Congdon Living Trust, 8060 Fox Meadow Lane, Granite Bay, CA 95746
2. Mortgagee and mortgagors: None
3. Tenants: Brian Burk, 3408 185th Street, Wever, IA 52658
4. Contract vendors or vendees: None

5. Lien Holders of Record: None

6. Others entitled to notice: None

TRACT IV

A. A description of the property sought to be condemned:

PARCEL 5687(L)- Pieper, Inc.

PART OF THE NORTHWEST QUARTER OF SECTION 21, TOWNSHIP 68 NORTH, RANGE 3 WEST OF THE FIFTH PRINCIPAL MERIDIAN, LEE COUNTY, IOWA. BEING MORE PARTICULARLY DESCRIBED AS FOLLOWS:

COMMENCING AT THE NORTHWEST CORNER OF SAID SECTION 21; THENCE S 01°15'07" E, ALONG THE WEST LINE OF THE NORTHWEST QUARTER OF SAID SECTION 21, A DISTANCE OF 793.75 FEET TO THE POINT OF BEGINNING; THENCE N 88°44'53" E, 88.73 FEET; THENCE N 82°10'16" E, 127.26 FEET; THENCE N 57°08'26" E, 123.46 FEET; THENCE N 38°13'18" E, 156.44 FEET; THENCE S 51°46'42" E, 80.00 FEET; THENCE S 38°13'18" W, 360.91 FEET; THENCE S 51°46'42" E, 15.00 FEET; THENCE ALONG A CURVE TO THE LEFT WHOSE RADIUS EQUALS 899.93 FEET, AN ARC DISTANCE OF 434.07 FEET, WITH A LONG CHORD BEARING S 24°24'13" W, 429.88 FEET TO THE NORTH LINE OF THE SOUTHEAST QUARTER OF THE NORTHWEST QUARTER OF SAID SECTION 21; THENCE S 89°26'14" W ALONG SAID NORTH LINE 77.53 FEET TO THE NORTHWEST CORNER OF THE SOUTHWEST QUARTER OF THE NORTHWEST QUARTER OF SAID SECTION 21; THENCE N 01°15'07" W, ALONG THE WEST LINE OF SAID SECTION 21, A DISTANCE OF 525.51 FEET BACK TO THE POINT OF BEGINNING, CONTAINING 1.265 ACRES, MORE OR LESS, EXCLUSIVE OF PRESENT ESTABLISHED ROADWAY.

BEING PART OF THE PARCEL AS DESCRIBED IN DOCUMENT NUMBER 2009N, PAGE 3823.

B. A plat showing the right-of-way sought to be condemned with reference to the description is attached as Exhibit TRACT IV -"L".

C. The property is agricultural.

D. The name and addresses of all record owners and lien and encumbrance owners and other parties who by law are entitled to notice regarding this tract are:

1. Owners: Pieper, Inc., 3635 190th Street, Wever, IA 52658

2. Mortgagee and mortgagors: Pilot Grove Savings Bank, 1341 Pilot Grove Rd, Pilot Grove, IA 52648

3. Tenants: Daniel Carroll, 1277 N. County Rd. 1600, Carthage IL 62321

4. Contract vendors or vendees: None

5. Lien Holders of Record: None

6. Others entitled to notice: None

TRACT V

A. A description of the property sought to be condemned:

PARCEL 5687(Q) - Pieper, Inc.

PART OF THE SOUTHEAST QUARTER OF SECTION 20, TOWNSHIP 68 NORTH, RANGE 3 WEST OF THE FIFTH PRINCIPAL MERIDIAN, LEE COUNTY, IOWA. BEING MORE PARTICULARLY DESCRIBED AS FOLLOWS:

COMMENCING AT THE EAST QUARTER CORNER OF SAID SECTION 20; THENCE S 89°18'29" W, ALONG THE NORTH LINE OF THE SOUTHEAST QUARTER OF SAID SECTION 20, A DISTANCE OF 170.55 FEET TO THE POINT OF BEGINNING; THENCE S 25°56'00" W, 327.97 FEET; THENCE S 42°43'00" W, 731.40 FEET; THENCE S 86°48'49" W, 140.32 FEET; THENCE ALONG A CURVE TO THE LEFT WHOSE RADIUS EQUALS 2075.00 FEET, AN ARC LENGTH OF 81.32 FEET, WITH A LONG CHORD BEARING N 51°02'43" E, 81.31 FEET; THENCE N 40°04'39" W, 10.00 FEET; THENCE ALONG A CURVE TO THE LEFT WHOSE RADIUS EQUALS 2065.00 FEET, AN ARC LENGTH OF 960.47 FEET, WITH A LONG CHORD BEARING N 36°35'52" E, 951.83 FEET; THENCE S 66°43'36" E, 5.00 FEET; THENCE ALONG A CURVE TO THE LEFT WHOSE RADIUS EQUALS 2070.00 FEET, AN ARC LENGTH OF 18.93 FEET, WITH A LONG CHORD BEARING N 23°00'41" E, 18.92 FEET TO THE NORTH LINE OF THE SOUTHEAST QUARTER OF SAID SECTION 20; THENCE N 89°18'29" E ALONG SAID NORTH LINE, 143.45 FEET BACK TO THE POINT OF BEGINNING, CONTAINING 1.565 ACRES, MORE OR LESS, EXCLUSIVE OF PRESENT ESTABLISHED ROADWAY.
BEING PART OF THE PARCEL AS DESCRIBED IN DEED BK. 68, PAGE 791.

B. A plat showing the right-of-way sought to be condemned with reference to the description is attached as Exhibit TRACT V Q.

C. The property is agricultural.

D. The name and addresses of all record owners and lien and encumbrance owners and other parties who by law are entitled to notice regarding this tract are:

1. Owners: Pieper, Inc., 3635 190th Street, Wever IA 52658

2. Mortgagee and mortgagors: Farm Credit Services of Midlands, FLCA, 2216 James Avenue, Mount Pleasant, IA 52641

Farm Credit Services of America, PCA, 2216 James Avenue, Mount Pleasant IA 52641

3. Tenants: Daniel Carroll, 1277 N. County Rd. 1600, Carthage IL 62321
4. Contract vendors or vendees: None
5. Lien Holders of Record: None
6. Others entitled to notice: None

TRACT VI

A. A description of the property sought to be condemned:

PARCEL 5687(J)- B & G Family Limited Partnership

PART OF THE SOUTHEAST QUARTER OF SECTION 17, TOWNSHIP 68 NORTH, RANGE 3 WEST OF THE FIFTH PRINCIPAL MERIDIAN, LEE COUNTY, IOWA. BEING MORE PARTICULARLY DESCRIBED AS FOLLOWS:

BEGINNING AT THE SOUTHEAST CORNER OF SAID SECTION 17; THENCE S 89°26'30" W, ALONG THE SOUTH LINE OF THE SOUTHEAST QUARTER OF SAID SECTION 17, A DISTANCE OF 135.01 FEET; THENCE N 01°15'07" W, 1336.45 FEET TO THE NORTH LINE OF THE SOUTHWEST QUARTER OF THE SOUTHEAST QUARTER OF SAID SECTION 17; THENCE N 89°30'40" E ALONG SAID NORTH LINE, 142.54 FEET TO THE EAST LINE OF THE SOUTHEAST QUARTER OF SAID SECTION 17; THENCE S 00°55'45"E, 1336.20 FEET TO THE POINT OF BEGINNING. CONTAINING 4.257 ACRES.

BEING PART OF THE PARCEL AS DESCRIBED IN DOCUMENT NUMBER 2001N, 36 E12.

B. A plat showing the right-of-way sought to be condemned with reference to the description is attached as Exhibit TRACT VI J.

C. The property is agricultural.

D. The name and addresses of all record owners and lien and encumbrance owners and other parties who by law are entitled to notice regarding this tract are:

1. Owners: B & G Family Limited Partnership, 1031 Denmark Hilltop, Fort Madison, IA 52627
2. Mortgagee and mortgagors:
3. Tenants: None
4. Contract vendors or vendees: None
5. Lien Holders of Record: None

6. Others entitled to notice: None

TRACT VII

- A. A description of the property sought to be condemned:

PARCEL 5687(K)- B & G Family Limited Partnership

PART OF THE NORTHEAST QUARTER OF SECTION 20, TOWNSHIP 68 NORTH, RANGE 3 WEST OF THE FIFTH PRINCIPAL MERIDIAN, LEE COUNTY, IOWA. BEING MORE PARTICULARLY DESCRIBED AS FOLLOWS:

BEGINNING AT THE NORTHEAST CORNER OF SAID SECTION 20; THENCE S 01°15'07" E, ALONG THE EAST LINE OF THE NORTHEAST QUARTER OF SAID SECTION 20, A DISTANCE OF 1319.25 FEET TO THE NORTH LINE OF THE SOUTHWEST QUARTER OF THE NORTHEAST QUARTER OF SAID SECTION 20; THENCE S 89°22'30" W ALONG SAID NORTH LINE, 135.01 FEET; THENCE N 01°15'07" W, 1319.41 FEET TO THE NORTH LINE OF THE NORTHEAST QUARTER OF SAID SECTION 20; THENCE N 89°26'30" E ALONG SAID NORTH LINE, 135.01 FEET BACK TO THE POINT OF BEGINNING, CONTAINING 4.088 ACRES.

BEING PART OF THE PARCEL AS DESCRIBED IN DOCUMENT NUMBER 2001N, 36 E12.

- B. A plat showing the right-of-way sought to be condemned with reference to the description is attached as Exhibit TRACT VII K.

- C. The property is agricultural.

- D. The name and addresses of all record owners and lien and encumbrance owners and other parties who by law are entitled to notice regarding this tract are:

1. Owners: B & G Family Limited Partnership, 1031 Denmark Hilltop, Fort Madison, IA 52627
2. Mortgagee and mortgagors:
3. Tenants: None
4. Contract vendors or vendees: None
5. Lien Holders of Record: None
6. Others entitled to notice: None

TRACT VIII

- A. A description of the property sought to be condemned:

PARCEL 5687(M)- B & G Family Limited Partnership

PART OF THE NORTHEAST QUARTER OF SECTION 20, TOWNSHIP 68 NORTH, RANGE 3 WEST OF THE FIFTH PRINCIPAL MERIDIAN, LEE COUNTY, IOWA. BEING MORE PARTICULARLY DESCRIBED AS FOLLOWS:

COMMENCING AT THE EAST QUARTER CORNER OF SAID SECTION 20; THENCE S 89°18'29" W, ALONG THE SOUTH LINE OF THE NORTHEAST QUARTER OF SAID SECTION 20, A DISTANCE OF 115.92 FEET TO THE POINT OF BEGINNING; THENCE CONTINUING ALONG SAID LINE S 89°18'29" W, 198.08 FEET; THENCE ALONG A CURVE TO THE LEFT WHOSE RADIUS EQUALS 2070.00 FEET, AN ARC LENGTH OF 867.13 FEET, WITH A LONG CHORD BEARING N 10°44'55" E, 860.81 FEET; THENCE N 01°15'07" W, 475.67 FEET TO THE NORTH LINE OF THE SOUTHEAST QUARTER OF THE NORTHEAST QUARTER OF SAID SECTION 20; THENCE N 89°22'30" E ALONG SAID NORTH LINE, 135.01 FEET TO THE EAST LINE OF THE NORTHEAST QUARTER OF SAID SECTION 20; THENCE S 01°15'07" E, 1144.21 FEET; THENCE ALONG A CURVE TO THE RIGHT WHOSE RADIUS EQUALS 627.97 FEET, AN ARC LENGTH OF 30.01 FEET, WITH A LONG CHORD BEARING S 25°13'10" W, 30.01 FEET; THENCE N 63°24'42" W, 22.00 FEET; THENCE S 26°35'18" W, 177.91 FEET BACK TO THE POINT OF BEGINNING, CONTAINING 2.967 ACRES, MORE OR LESS, EXCLUSIVE OF PRESENT ESTABLISHED ROADWAY. BEING PART OF THE PARCEL AS DESCRIBED IN DOCUMENT NUMBER 2001N, 36 E12.

B. A plat showing the right-of-way sought to be condemned with reference to the description is attached as Exhibit TRACT VIII M.

C. The property is agricultural.

D. The name and addresses of all record owners and lien and encumbrance owners and other parties who by law are entitled to notice regarding this tract are:

1. Owners: B & G Family Limited Partnership, 1031 Denmark Hilltop, Fort Madison, IA 52627
2. Mortgagee and mortgagors:
3. Tenants: None
4. Contract vendors or vendees: None
5. Lien Holders of Record: None
6. Others entitled to notice: None

TRACT IX

A. A description of the property sought to be condemned:

PARCEL 5687(P)- B & G Family Limited Partnership

PART OF THE SOUTHEAST QUARTER OF SECTION 20, TOWNSHIP 68 NORTH, RANGE 3 WEST OF THE FIFTH PRINCIPAL MERIDIAN, LEE COUNTY, IOWA. BEING MORE PARTICULARLY DESCRIBED AS FOLLOWS:

COMMENCING AT THE EAST QUARTER CORNER OF SAID SECTION 20; THENCE S 89°18'29" W, ALONG THE NORTH LINE OF THE SOUTHEAST QUARTER OF SAID SECTION 20, A DISTANCE OF 115.92 FEET TO THE POINT OF BEGINNING; THENCE S 26°35'18" W, 199.77 FEET; THENCE ALONG A CURVE TO THE RIGHT WHOSE RADIUS EQUALS 987.93 FEET, AN ARC LENGTH OF 131.13 FEET, WITH A LONG CHORD BEARING S 30°23'27" W, 131.03 FEET; THENCE ALONG A CURVE TO THE RIGHT WHOSE RADIUS EQUALS 2235.00 FEET, AN ARC LENGTH OF 601.14 FEET, WITH A LONG CHORD BEARING S 36°53'14" W, 599.33 FEET; THENCE N 45°24'27" W, 8.12 FEET; THENCE S 43°01'05" W, 181.43 FEET; THENCE ALONG A CURVE TO THE RIGHT WHOSE RADIUS EQUALS 1979.85 FEET, AN ARC LENGTH OF 485.15 FEET, WITH A LONG CHORD BEARING S 54°25'05" W, 483.94 FEET; THENCE S 60°10'50" W, 103.90 FEET; THENCE ALONG A CURVE TO THE RIGHT WHOSE RADIUS EQUALS 1984.85 FEET, AN ARC LENGTH OF 63.74 FEET, WITH A LONG CHORD BEARING S 65°21'29" W, 63.74 FEET; THENCE N 01°07'40" W, 194.32 FEET; THENCE ALONG A CURVE TO THE LEFT WHOSE RADIUS EQUALS 2075.00 FEET, AN ARC LENGTH OF 420.81 FEET, WITH A LONG CHORD BEARING N 57°58'40" E, 420.09 FEET; THENCE N 86°48'49" E, 140.32 FEET; THENCE N 42°43'00" E, 731.40 FEET; THENCE N 25°56'00" E, 327.98 FEET TO THE NORTH LINE OF THE SOUTHEAST QUARTER OF SAID SECTION 20; THENCE N 89°18'29" E ALONG SAID NORTH LINE, 54.63 FEET BACK TO THE POINT OF BEGINNING, CONTAINING 0.941 ACRES, MORE OR LESS, EXCLUSIVE OF PRESENT ESTABLISHED ROADWAY. BEING PART OF THE PARCEL AS DESCRIBED IN DOCUMENT 1997N, 132 D10.

B. A plat showing the right-of-way sought to be condemned with reference to the description is attached as Exhibit TRACT IX P.

C. The property is agricultural.

D. The name and addresses of all record owners and lien and encumbrance owners and other parties who by law are entitled to notice regarding this tract are:

1. Owners: B & G Family Limited Partnership, 1031 Denmark Hilltop, Fort Madison, IA 52627
2. Mortgagee and mortgagors:
3. Tenants: None
4. Contract vendors or vendees: None
5. Lien Holders of Record: None
6. Others entitled to notice: None

TRACT X

A. A description of the property sought to be condemned:

PARCEL 5687(R)- B & G Family Limited Partnership

PART OF THE SOUTHEAST QUARTER OF SECTION 20, TOWNSHIP 68 NORTH, RANGE 3 WEST OF THE FIFTH PRINCIPAL MERIDIAN, LEE COUNTY, IOWA. BEING MORE PARTICULARLY DESCRIBED AS FOLLOWS:

BEGINNING AT THE SOUTHWEST CORNER OF THE NORTHWEST QUARTER OF THE SOUTHEAST QUARTER OF SAID SECTION 20; THENCE N 00°55'39" W, ALONG THE WEST LINE OF THE SOUTHEAST QUARTER OF SAID SECTION 20, A DISTANCE OF 50.00 FEET; THENCE N 89°19'50" E, 263.73 FEET; THENCE N 00°40'10" W, 15.00 FEET; THENCE N 89°19'50" E, 171.35 FEET; THENCE ALONG A CURVE TO THE LEFT WHOSE RADIUS EQUALS 2085.00 FEET, AN ARC LENGTH OF 464.30 FEET, WITH A LONG CHORD BEARING N 82°57'04" E, 463.34 FEET; THENCE N 13°25'42" W, 5.00 FEET; THENCE ALONG A CURVE TO THE LEFT WHOSE RADIUS EQUALS 2080.00 FEET, AN ARC LENGTH OF 386.98 FEET, WITH A LONG CHORD BEARING N 71°14'30" E, 386.42 FEET; THENCE N 24°05'17" W, 5.00 FEET; THENCE ALONG A CURVE TO THE LEFT WHOSE RADIUS EQUALS 2075.00 FEET, AN ARC LENGTH OF 76.94 FEET, WITH A LONG CHORD BEARING N 64°50'59" E, 76.93 FEET; THENCE S 01°09'11" E, 194.32 FEET; THENCE ALONG A CURVE TO THE RIGHT WHOSE RADIUS EQUALS 1984.85 FEET, AN ARC LENGTH OF 238.81 FEET, WITH A LONG CHORD BEARING S 69°43'30" W, 238.67 FEET TO THE SOUTH LINE OF THE NORTHWEST QUARTER OF THE SOUTHEAST QUARTER OF SAID SECTION 20; THENCE S 89°09'13" W ALONG SAID SOUTH LINE, 1106.30 FEET BACK TO THE POINT OF BEGINNING, CONTAINING 0.824 ACRES, MORE OR LESS, EXCLUSIVE OF PRESENT ESTABLISHED ROADWAY.
BEING PART OF THE PARCEL AS DESCRIBED IN DEOCUMENT 1997N, 132 D10.

B. A plat showing the right-of-way sought to be condemned with reference to the description is attached as Exhibit TRACT X "R".

C. The property is agricultural.

D. The name and addresses of all record owners and lien and encumbrance owners and other parties who by law are entitled to notice regarding this tract are:

1. Owners: B & G Family Limited Partnership, 1031 Denmark Hilltop, Fort Madison, IA 52627
2. Mortgagee and mortgagors:
3. Tenants: None
4. Contract vendors or vendees: None
5. Lien Holders of Record: None

6. Others entitled to notice: None

TRACT XI

- A. A description of the property sought to be condemned:

PARCEL 5687(S)- B & G Family Limited Partnership

PART OF THE SOUTHEAST QUARTER OF SECTION 20, TOWNSHIP 68 NORTH, RANGE 3 WEST OF THE FIFTH PRINCIPAL MERIDIAN, LEE COUNTY, IOWA. BEING MORE PARTICULARLY DESCRIBED AS FOLLOWS:

BEGINNING AT THE NORTHWEST CORNER OF THE SOUTHWEST QUARTER OF THE SOUTHEAST QUARTER OF SAID SECTION 20; THENCE N 89°09'13" E ALONG THE NORTH LINE OF THE SOUTHWEST QUARTER OF THE SOUTHEAST QUARTER OF SAID SECTION 20, A DISTANCE OF 1106.30 FEET; THENCE ALONG A CURVE TO THE RIGHT WHOSE RADIUS EQUALS 1984.85 FEET, AN ARC LENGTH OF 9.22 FEET, WITH A LONG CHORD BEARING S 73°18'17" W, 9.22 FEET; THENCE S 72°11'15" W, 104.17 FEET; THENCE ALONG A CURVE TO THE RIGHT WHOSE RADIUS EQUALS 1989.85 FEET, AN ARC LENGTH OF 47.25 FEET, WITH A LONG CHORD BEARING S 77°07'06" W, 47.25 FEET; THENCE ALONG A CURVE TO THE RIGHT WHOSE RADIUS EQUALS 2250.00 FEET, AN ARC LENGTH OF 521.51 FEET, WITH A LONG CHORD BEARING S 82°41'25" W, 520.34 FEET; THENCE S 89°19'50" W, 434.13 FEET TO THE WEST LINE OF THE SOUTHEAST QUARTER OF SAID SECTION 20; THENCE N 01°04'48" W, 100.00 FEET BACK TO THE POINT OF BEGINNING, CONTAINING 0.183 ACRES, MORE OR LESS, EXCLUSIVE OF PRESENT ROADWAY. BEING PART OF THE PARCEL AS DESCRIBED IN DEOCUMENT 1997N, 132 D10.

- B. A plat showing the right-of-way sought to be condemned with reference to the description is attached as Exhibit TRACT XI S.

- C. The property is agricultural.

- D. The name and addresses of all record owners and lien and encumbrance owners and other parties who by law are entitled to notice regarding this tract are:

1. Owners: B & G Family Limited Partnership, 1031 Denmark Hilltop, Fort Madison, IA 52627
2. Mortgagee and mortgagors:
3. Tenants: None
4. Contract vendors or vendees: None
5. Lien Holders of Record: None
6. Others entitled to notice: None

WHEREFORE, the undersigned applicant on behalf of Lee County, Iowa, hereby requests that the Honorable Mary Ann Brown, Chief Judge of the Eighth Judicial District acting in accordance with Chapter 6B, Code of Iowa, 2015, appoint a commission of six qualified persons to view the premises and appraise the damages which the owners, lien holders, incumbrancers and other persons affected will sustain by reason of this of this Condemnation.

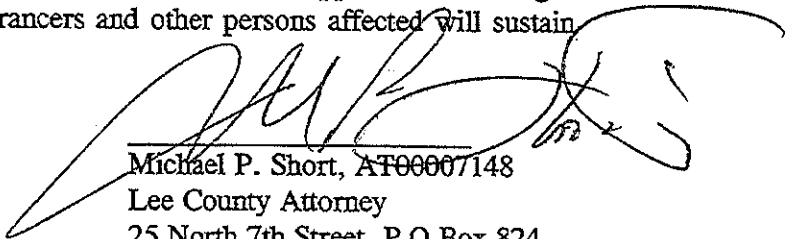

Michael P. Short, AT00007148
Lee County Attorney
25 North 7th Street, P O Box 824
Keokuk, IA 52632
(319)524-9590
Fax: (319)524-9592

Filed in the office of the Chief Judge of the Eighth Judicial District on this the 26 day of January, 2015.



Mary Ann Brown, Chief Judge, 8th
Judicial District of Iowa

A copy filed of record in the Office of the Sheriff of Lee County on this the _____ day of January, 2015.

James A. Sholl
Lee County Sheriff

State of Iowa)
:ss
County of Lee)

I, Michael P. Short, being first duly sworn upon oath and affidavit do hereby depose and state that I hereby certify in accordance with Section 6B3(7) that the documents presented to the Lee County Recorder for recording are the original documents and that the statements accompanying the same are true and correct. Certified and present on this the 27 day of January, 2015, as the free and voluntary act of the affiant.

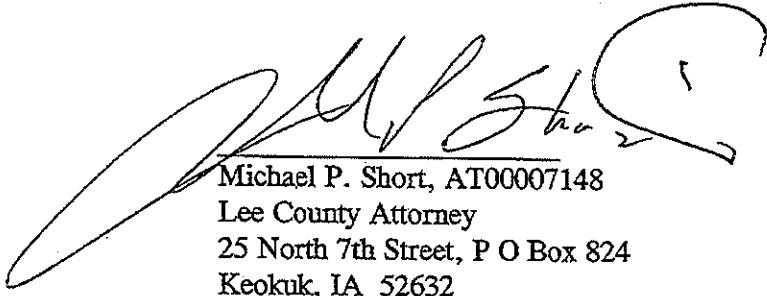

Michael P. Short, AT00007148
Lee County Attorney
25 North 7th Street, P O Box 824
Keokuk, IA 52632
(319)524-9590 Fax (319) 524-9592

Before me, the undersigned notary public in and for Lee County and the State of Iowa, personally appeared Michael P. Short, known by me to be the County Attorney for Lee County, Iowa, and who, was by me first duly sworn upon oath and affidavit and deposed and did state that the contents of the above and foregoing affidavit are true and correct and, the same was signed by him as a voluntary act and deed.

Dated this the 27th day of January, 2015.

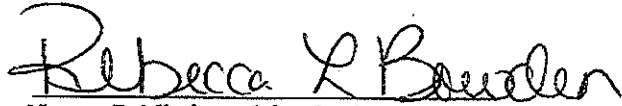

Rebecca L Bowden
Notary Public in and for the State of Iowa

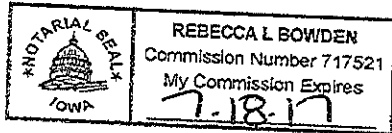

Tract I E

PREPARED BY: CHESTER V. BROWN, POEPPING, STONE, BACH AND ASSOCIATES, INC.
100 SOUTH 54TH ST., P.O. BOX #709, QUINCY, IL, 62306, PH. 217-223-4605

CONNIE KETCHUM ROADWAY EASEMENT PLAT

PARCEL NO. 5687-E

RED FROM DIANE LANGE
DANNY LANGE

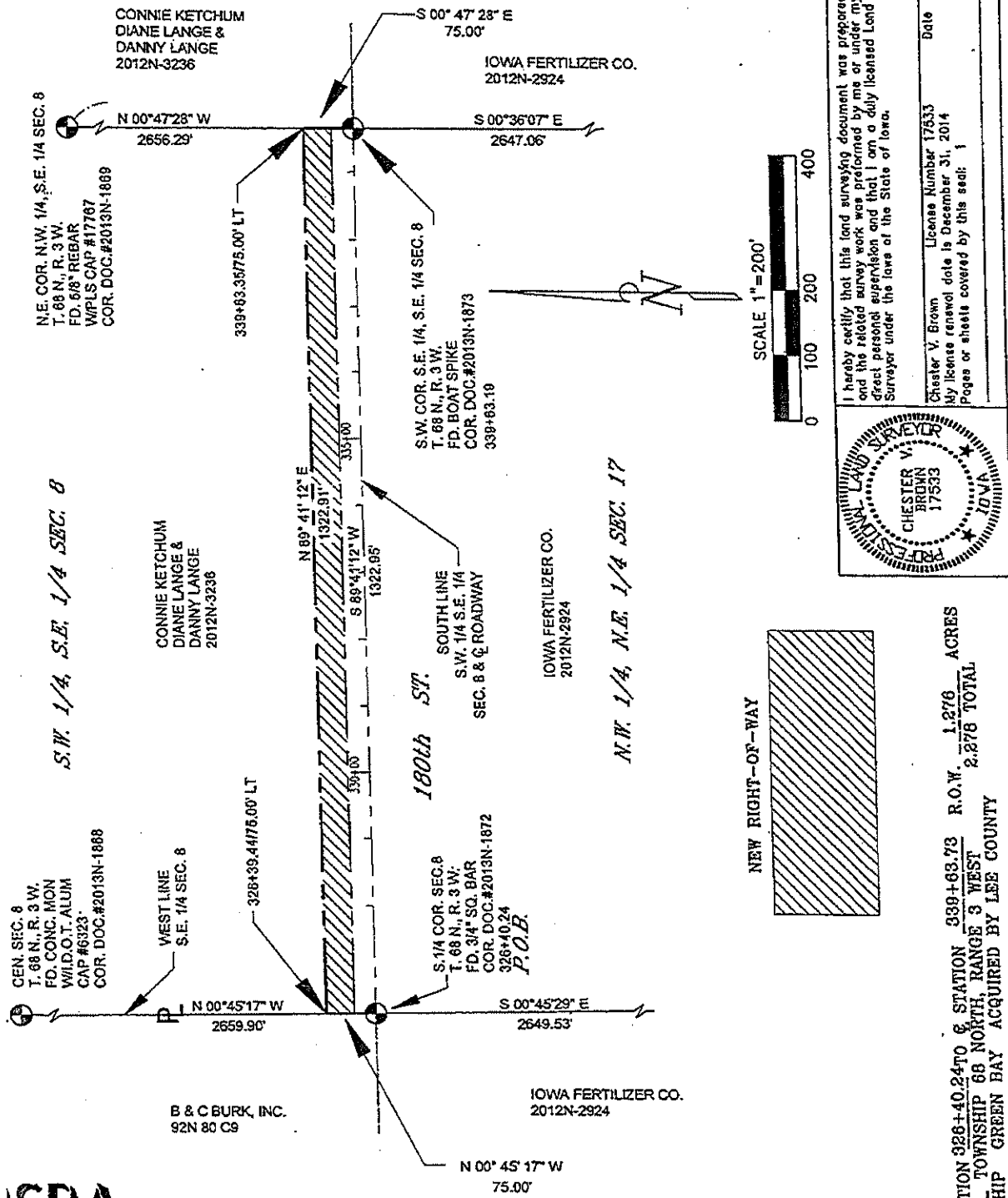

I hereby certify that this land surveying document was prepared and the related survey work was performed by me or under my direct personal supervision and that I am a duly licensed Land Surveyor under the laws of the State of Iowa.

Chester V. Brown License Number 17533 Date _____
My license renewal date is December 31, 2014
Pages or sheets covered by this seal: 1

IOWA LAND SURVEYOR
CHESTER V. BROWN
17533
IOWA

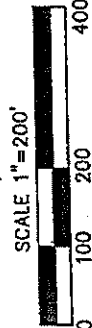

N.W. 1/4, N.E. 1/4 SEC. 17

S.W. 1/4, S.E. 1/4 SEC. 8

FROM & STATION 326+40.24 TO & STATION 339+63.73 R.O.W. 1.276 ACRES
SECTION 8, TOWNSHIP 68 NORTH, RANGE 3 WEST 2.276 TOTAL
CIVIL TOWNSHIP GREEN BAY ACQUIRED BY LEE COUNTY

Project No.: SVK 13-504



POEPPING, STONE, BACH & ASSOCIATES, INC.
ARCHITECTS ENGINEERS PLANNERS SURVEYORS

0 SO. 54th ST., JINCY, ILLINOIS 7-223-4605
3523 MAIN ST., KEOKUK, IOWA 319-524-8730
801 BROADWAY, HANNIBAL, MISSOURI 573-406-0541

Tract III H

PREPARED BY: CHESTER V. BROWN, POEPPING, STONE, BACH AND ASSOCIATES, INC.
 100 SOUTH 54TH ST., P.O. BOX #709, QUINCY, IL 62305, PH. 217-223-4605

ROADWAY EASEMENT PLAT

PARCEL NO. 5687-H

ACQUIRED FROM LARRY L. & KATHLEEN G. COGDIN AS CO-TRUSTEES OF THE COLGODON LUNIC TRUST

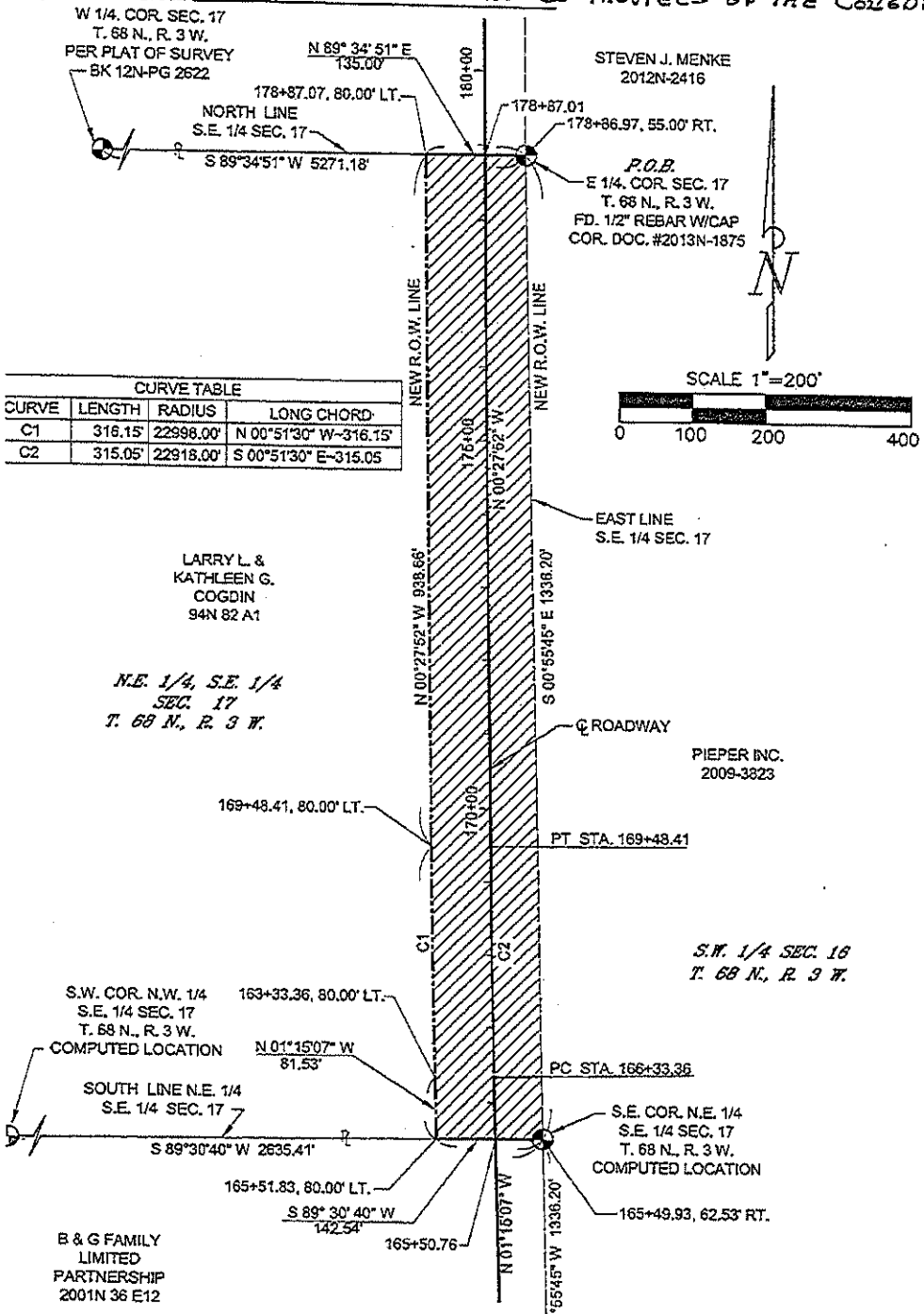

CURVE TABLE			
CURVE	LENGTH	RADIUS	LONG CHORD
C1	316.15'	22998.00'	N 00° 51' 30\" W-316.15'
C2	315.05'	22918.00'	S 00° 51' 30\" E-315.05'

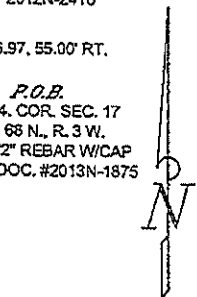

I hereby certify that this land surveying document was prepared and the related survey work was performed by me or under my direct personal supervision and that I am a duly licensed Land Surveyor under the laws of the State of Iowa.

Chester V. Brown License Number 17533
 My license renewal date is December 31, 2014
 Pages or sheets covered by this sheet: 1

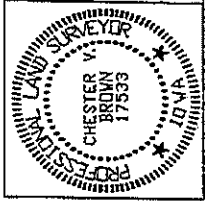

LARRY L. & KATHLEEN G. COGDIN
 94N 82 A1

N.E. 1/4, S.E. 1/4
 SEC. 17
 T. 68 N., R. 3 W.

PIEPER INC.
 2009-3823

S.W. 1/4 SEC. 18
 T. 68 N., R. 3 W.

S.W. COR. N.W. 1/4
 S.E. 1/4 SEC. 17
 T. 68 N., R. 3 W.
 COMPUTED LOCATION

SOUTH LINE N.E. 1/4
 S.E. 1/4 SEC. 17
 S 89° 30' 40\" W 2635.41'

B & G FAMILY LIMITED PARTNERSHIP
 2001N 36 E12

S.E. COR. N.E. 1/4
 S.E. 1/4 SEC. 17
 T. 68 N., R. 3 W.
 COMPUTED LOCATION

S.E. COR. SEC. 17
 T. 68 N., R. 3 W.
 FD. 1/2\" REBAR W/CAP
 COR. DOC.#2103N-1876

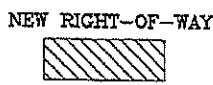

FROM & STATION 165+50.76 TO & STATION 178+87.01 R.O.W. 4.297 ACRES
 SECTION 17 TOWNSHIP 68 NORTH, RANGE 3 WEST
 CIVIL TOWNSHIP GREEN BAY ACQUIRED BY LEE COUNTY

SBA POEPPING, STONE, BACH & ASSOCIATES, INC.
 ARCHITECTS ENGINEERS PLANNERS SURVEYORS
 00 SO. 54th ST., QUINCY, ILLINOIS 17-223-4605
 3523 MAIN ST., KEOKUK, IOWA 319-524-8730
 801 BROADWAY, HANNIBAL, MISSOURI 573-408-0541

Project No.: SVK 13-504

tract IV - L

PREPARED BY: CHESTER V. BROWN, POEPPING, STONE, BACH AND ASSOCIATES, INC.
100 SOUTH 54TH ST., P.O. BOX #709, QUINCY, IL, 62306, PH. 217-223-4605

ROADWAY EASEMENT PLAT

PARCEL NO. 5687-L

AQUIRED FROM **PIEPER, INC.**

S.E. 1/4 S.E. 1/4
SEC. 17
T. 68 N., R. 3 W.

S.W. 1/4 S.W. 1/4
SEC. 16
T. 68 N., R. 3 W.

N.E. 1/4, N.E. 1/4
SEC. 20
T. 68 N., R. 3 W.

8 & G FAMILY
LIMITED
PARTNERSHIP
2001N36 E12

LINE	LENGTH	BEARING
L1	86.73	N 88°44'53" E
L2	127.26	N 82°10'16" E
L3	123.46	N 57°08'28" E
L4	156.44	N 36°13'18" E
L5	80.00	S 57°46'42" E
L6	15.00	S 57°46'42" E
L7	360.91	S 38°13'18" W
L8	54.51	N 01°15'07" W

I hereby certify that this land surveying document was prepared and the related survey work was performed by me or under my direct personal supervision and that I am a duly licensed Land Surveyor under the laws of the State of Iowa.

Chester V. Brown
License Number 17533
Date
My license renewal date is December 31, 2014
Pages or sheets covered by this plat: 1

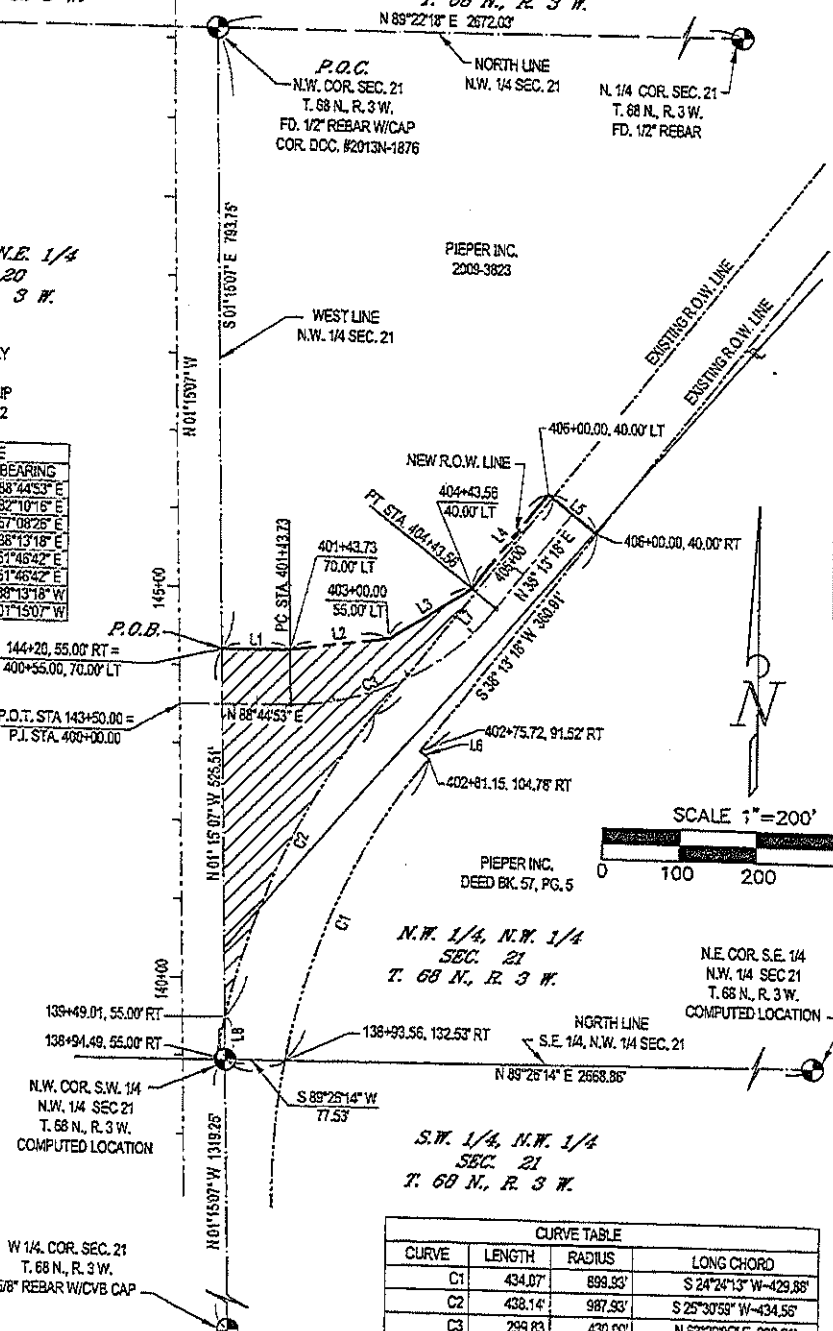
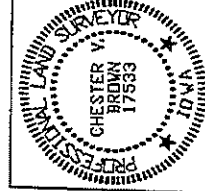

CURVE	LENGTH	RADIUS	LONG CHORD
C1	434.07'	899.93'	S 24°24'13" W-429.88'
C2	438.14'	987.93'	S 25°30'53" W-434.58'
C3	299.83'	430.00'	N 63°23'05" E-290.21'

NEW RIGHT-OF-WAY

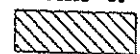

FROM & STATION 400+00.00 TO & STATION 406+00.00. R.O.W. 1.265 ACRES
SECTION 17 TOWNSHIP 68 NORTH RANGE 3 WEST
CIVIL TOWNSHIP GREEN BAY ACQUIRED BY LEE COUNTY 2.798 ACRES TOTAL

Project No.: SVK 13-504



POEPPING, STONE, BACH & ASSOCIATES, INC.
ARCHITECTS ENGINEERS PLANNERS SURVEYORS

100 SOUTH 54TH ST., QUINCY, ILLINOIS 62306-0709
3523 MAIN ST., KEOKUK, IOWA 52450
801 BROADWAY, HANNIBAL, MISSOURI 63401

Tract V Q

PREPARED BY: CHESTER V. BROWN, POEPPING, STONE, BACH AND ASSOCIATES, INC.
100 SOUTH 54TH ST., P.O. BOX #709, QUINCY, IL 62306, PH. 217-223-4605

ROADWAY EASEMENT PLAT

PARCEL NO. 5687-Q

ACQUIRED FROM **PIEPER, INC.**

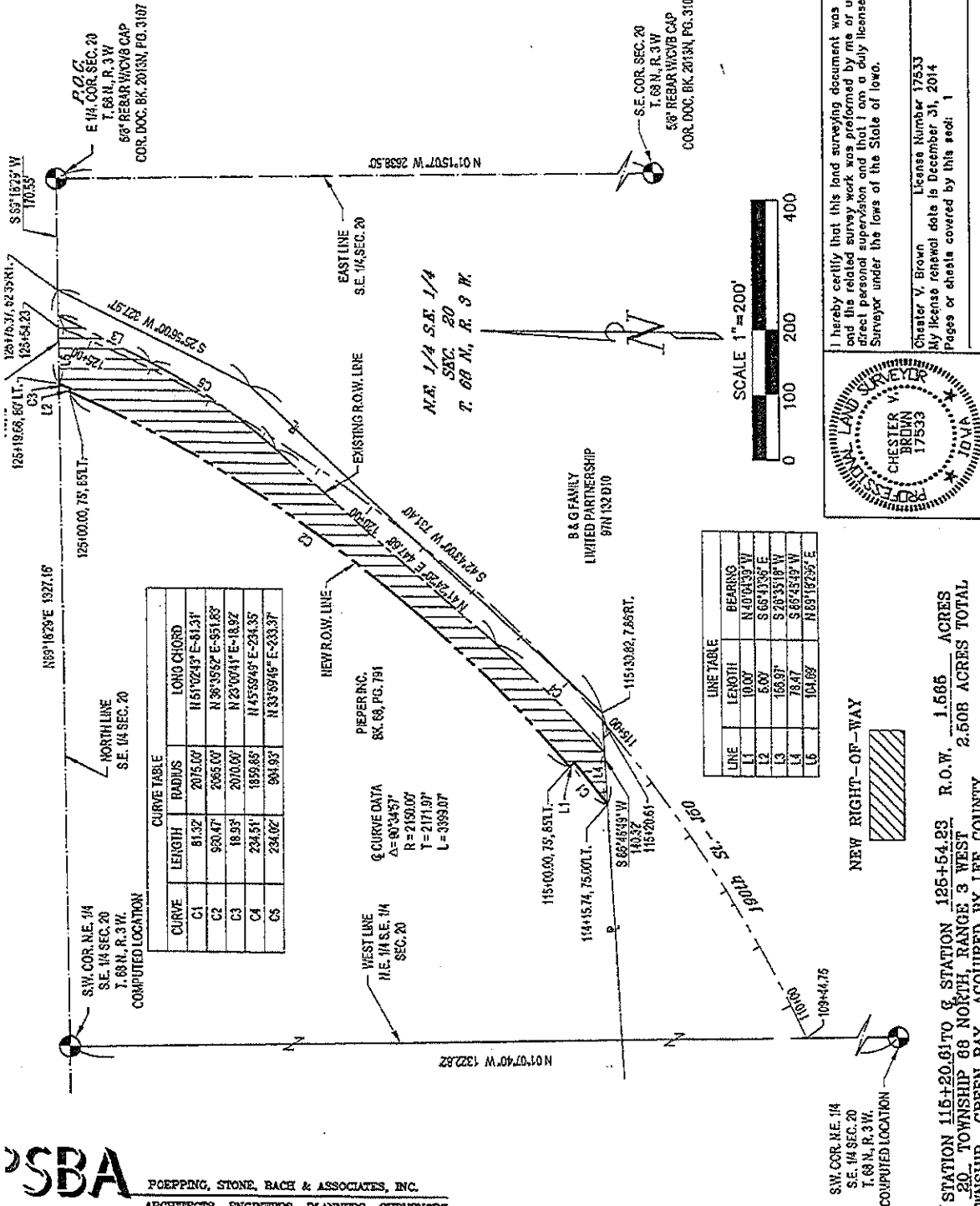

POEPPING, STONE, BACH & ASSOCIATES, INC.
ARCHITECTS ENGINEERS PLANNERS SURVEYORS

100 SO. 54th ST., QUINCY, ILLINOIS 217-223-4605
 3523 MAIN ST., KEOKUK, IOWA 319-524-8730
 801 BROADWAY, HANNIBAL, MISSOURI 573-406-0541

FROM SECTION 20, TOWNSHIP 68 NORTH, RANGE 3 WEST, CIVIL TOWNSHIP GREEN BAY ACQUIRED BY LEE COUNTY
 R.O.W. 1.565 ACRES
 2.508 ACRES TOTAL

Project No.: SVK 13-5D4

Tract VI J

PREPARED BY: CHESTER V. BROWN, POEPPING, STONE, BACH AND ASSOCIATES, INC.
100 SOUTH 54TH ST., P.O. BOX #709, QUINCY, IL, 62306. PH. 217-223-4605

ROADWAY EASEMENT PLAT

PARCEL NO. 5687-J

AQUIRED FROM: **B & G FAMILY LIMITED PARTNERSHIP**

LARRY L. & KATHLEEN G. CONGDON - 94N 82 A1

S. 1/4 COR. S.W. 1/4, SEC. 17
AP. LOCATION

N. LINE, S.W. 1/4, S.E. 1/4, SEC. 17

B & G FAMILY LIMITED PARTNERSHIP
2001N 36 E12

S.E. 1/4 S.E. 1/4 SEC. 17
T. 68 N., R. 3 W.

S. 1/4 COR. SEC. 17
T. 68 N., R. 3 W.
COMPUTED LOCATION

SOUTH LINE, SEC. 17

152+15.38, 80.00' LT.

S 89° 26' 30" W 2639.39'

S 89° 28' 50" W, 135.01'

B & G FAMILY LIMITED PARTNERSHIP
2001N 36 E12

SBA

POEPPING, STONE, BACH & ASSOCIATES, INC.
ARCHITECTS ENGINEERS PLANNERS SURVEYORS

100 SO. 54TH ST., QUINCY, ILLINOIS 217-223-4605
3525 MAIN ST., KEOKUK, IOWA 319-624-8730
601 BROADWAY, HANNIBAL, MISSOURI 573-406-0541

EE COUNTY

E 1/4, COR. SEC. 17
T. 68 N., R. 3 W.
FD. 1/2" REBAR W/CAP
COR. DOC. 2013N-1875

N.E. COR. S.E. 1/4
S.E. 1/4 SEC. 17
COMP. LOCATION
185+49.83, 62.53' RT.

EAST LINE, S.E. 1/4 SEC. 17

PIEPER INC.
2009-3823

S.W. 1/4 SEC. 16
T. 68 N., R. 3 W.

PROPOSED ROAD

P.O.B.
S.E. COR. SEC. 17
T. 68 N., R. 3 W.
FD. 1/2" REBAR W/ CAP
COR. DOC. #2013-1876
152+13.75, 55.00' RT.

PIEPER INC.
2009-3823

I hereby certify that this land surveying document was prepared and the related survey work was performed by me or under my direct personal supervision and that I am a duly licensed Land Surveyor under the laws of the State of Iowa.

Chester V. Brown	License Number 17533	Date
My license renewal date is December 31, 2014		
Pages or sheets covered by this plat: 1		

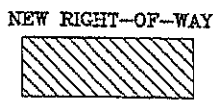
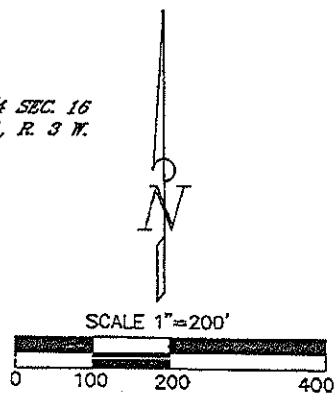

FROM & STATION 162+14.41 TO & STATION 165+50.76 R.O.W. 4.257 ACRES
SECTION 17, TOWNSHIP 68 NORTH, RANGE 3 WEST
CIVIL TOWNSHIP GREEN BAY ACQUIRED BY LEE COUNTY

SA Project No.: SVK 13-504

Tract VII K

PREPARED BY: CHESTER V. BROWN, POEPPING, STONE, BACH AND ASSOCIATES, INC.
100 SOUTH 54TH ST., P.O. BOX #709, QUINCY, IL, 62306, PH. 217-223-4605

ROADWAY EASEMENT PLAT

PARCEL NO. 5687-K

ACQUIRED FROM B & G FAMILY LIMITED PARTNERSHIP

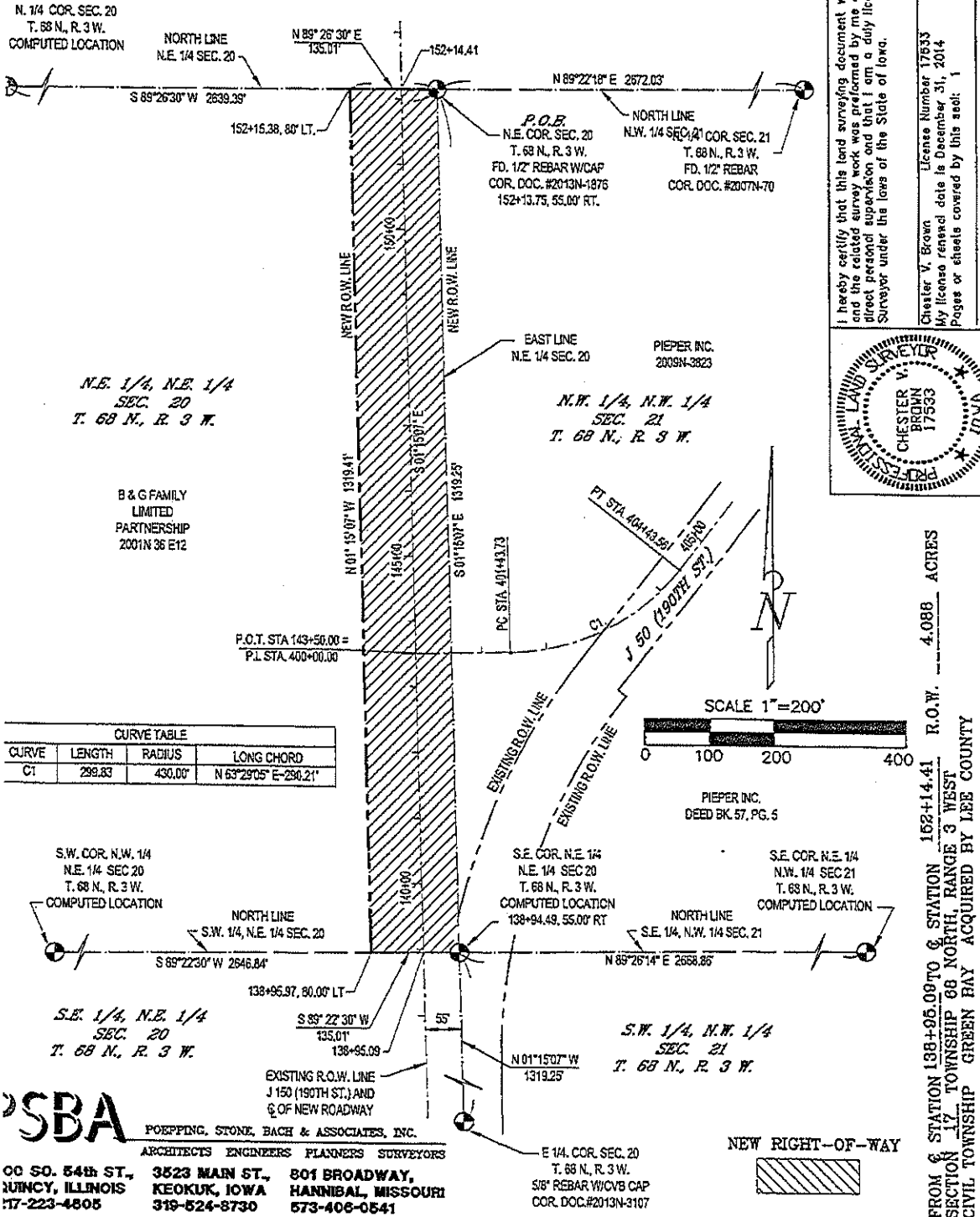

I hereby certify that this land surveying document was prepared and the related survey work was performed by me or under my direct personal supervision and that I am a duly licensed Land Surveyor under the laws of the State of Iowa.

Chester V. Brown License Number 17533 Date _____
My license renewal date is December 31, 2014
Pages or sheets covered by this set: 1

PROFESSIONAL LAND SURVEYOR
CHESTER V. BROWN
17533
IOWA

SBA
POEPPING, STONE, BACH & ASSOCIATES, INC.
ARCHITECTS ENGINEERS PLANNERS SURVEYORS

100 SO. 54th ST., QUINCY, ILLINOIS 62306-7009
3523 MAIN ST., KEOKUK, IOWA 52424-2730
801 BROADWAY, HANNIBAL, MISSOURI 63406-0541

PH. 217-223-4605 FAX 217-223-4605

FROM & STATION 138+05.09 TO & STATION 162+14.41 R.O.W. 4.088 ACRES
SECTION 17, TOWNSHIP 68 NORTH, RANGE 3 WEST
CIVIL TOWNSHIP GREEN BAY ACQUIRED BY LEE COUNTY

A Project No.: SVK 13-504

Tract VIII M

PREPARED BY: CHESTER V. BROWN, POEPPING, STONE, BACH AND ASSOCIATES, INC.
100 SOUTH 54TH ST., P.O. BOX #709, QUINCY, IL 62306, PH. 217-223-4605

ROADWAY EASEMENT PLAT

PARCEL NO. 5687-M

AQUIRED FROM B & G FAMILY LIMITED PARTNERSHIP

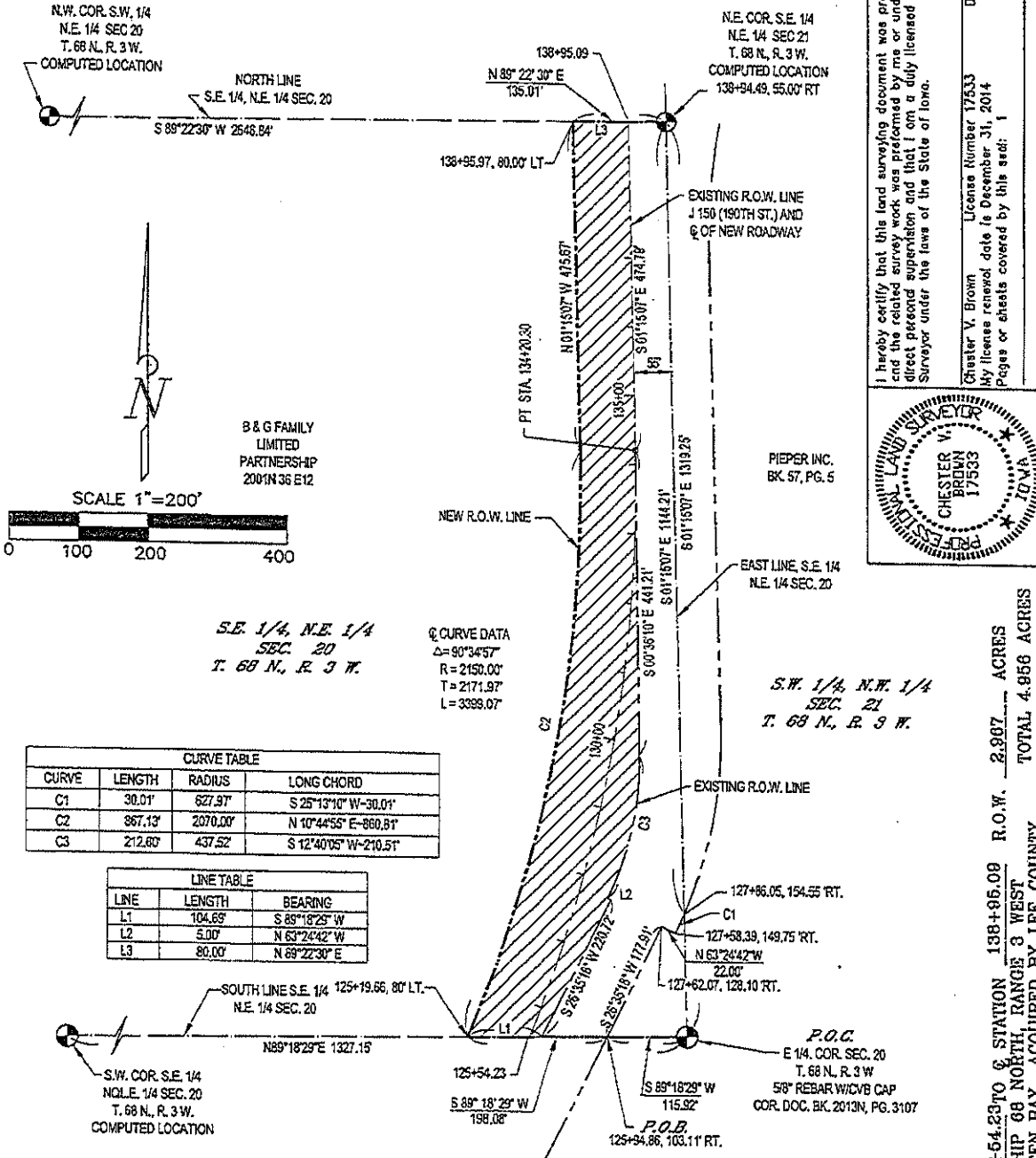

I hereby certify that this land surveying document was prepared and the related survey work was performed by me or under my direct personal supervision and that I am a duly licensed Land Surveyor under the laws of the State of Iowa.

Chester V. Brown License Number 17533 Date
My license renewal date is December 31, 2014
Pages or sheets covered by this plat: 1

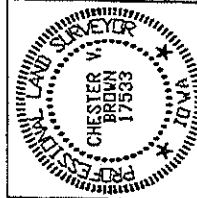

CURVE TABLE			
CURVE	LENGTH	RADIUS	LONG CHORD
C1	30.01'	627.97'	S 25°13'10" W-30.01'
C2	867.13'	2070.00'	N 10°44'55" E-860.81'
C3	212.80'	437.52'	S 12°40'05" W-210.51'

LINE TABLE		
LINE	LENGTH	BEARING
L1	104.69'	S 89°18'29" W
L2	5.00'	N 63°24'42" W
L3	80.00'	N 69°22'30" E

FROM & STATION 125+54.23 TO & STATION 138+95.09 R.O.W. 2,997 ACRES
SECTION 20 TOWNSHIP 68 NORTH, RANGE 3 WEST TOTAL 4,956 ACRES
CIVIL TOWNSHIP GREEN BAY ACQUIRED BY LEE COUNTY

SBA POEPPING, STONE, BACH & ASSOCIATES, INC.
ARCHITECTS ENGINEERS PLANNERS SURVEYORS
100 SO. 54th ST., QUINCY, ILLINOIS 217-223-4605
3523 MAIN ST., KEOKUK, IOWA 319-524-8730
801 BROADWAY, HANNIBAL, MISSOURI 573-406-0541

NEW RIGHT-OF-WAY



Tract IX P

PREPARED BY: CHESTER V. BROWN, POEPPING, STONE, BACH AND ASSOCIATES, INC.
100 SOUTH 54TH ST., P.O. BOX #709, QUINCY, IL, 62306, PH. 217-223-4605

ROADWAY EASEMENT PLAT

PARCEL NO. 5687-P

B & G FAMILY
ACQUIRED FROM LIMITED PARTNERSHIP

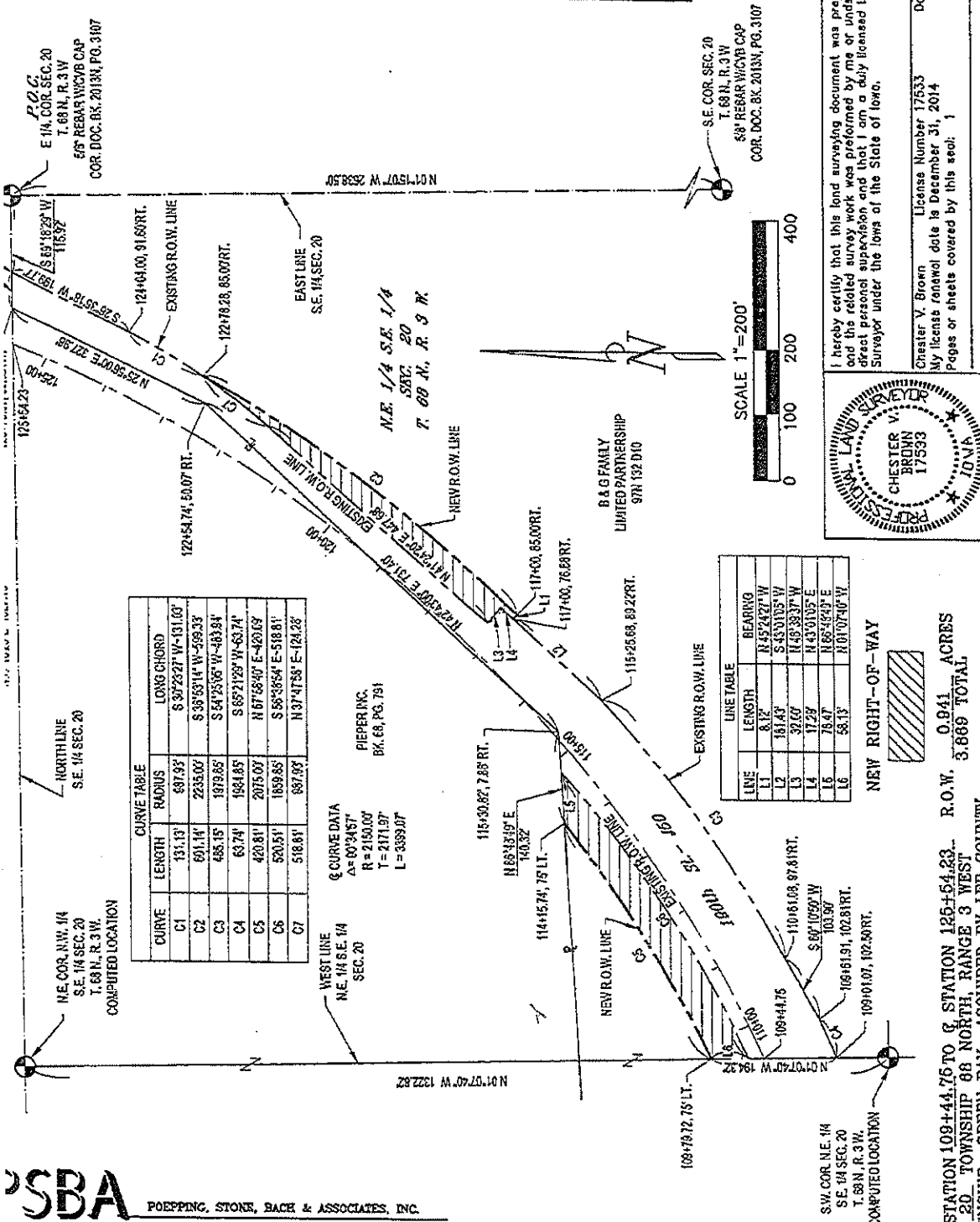

CURVE	LENGTH	RADIUS	LONG CHORD
C1	131.13'	687.93'	S 37°23'27\" W-131.63'
C2	691.14'	2335.00'	S 39°53'14\" W-599.33'
C3	488.15'	1979.85'	S 54°25'56\" W-463.84'
C4	63.74'	1484.85'	S 85°21'29\" W-63.74'
C5	420.81'	2075.00'	N 67°43'40\" E-420.69'
C6	520.51'	1869.85'	S 85°36'54\" E-518.81'
C7	518.81'	887.83'	N 37°47'53\" E-124.23'

Q & CURVE DATA
Δ = 90°24'57\"
R = 2160.00'
T = 2171.97'
L = 3389.07'

LINE	LENGTH	BEARING
L1	8.12'	N 45°24'27\" W
L2	181.43'	S 43°01'05\" W
L3	32.60'	N 49°33'37\" W
L4	17.29'	N 03°01'05\" E
L5	78.87'	N 65°34'49\" E
L6	58.13'	N 01°07'40\" W



NEW RIGHT-OF-WAY
0.941 ACRES
3.868 TOTAL

I hereby certify that this land surveying document was prepared and the related survey work was performed by me or under my direct personal supervision and that I am a duly licensed Land Surveyor under the laws of the State of Iowa.

Chester V. Brown License Number 17533 Date
My license renewal date is December 31, 2014
Pages or sheets covered by this seal: 1

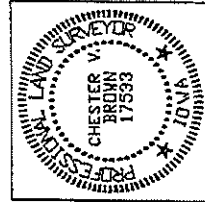

SBA POEPPING, STONE, BACH & ASSOCIATES, INC.
ARCHITECTS ENGINEERS PLANNERS SURVEYORS
100 SO. 54TH ST., QUINCY, ILLINOIS 217-223-4605
3523 MAIN ST., KEOKUK, IOWA 319-524-8730
801 BROADWAY, HANNIBAL, MISSOURI 573-406-0541

FROM Q & STATION 109+44.75 TO Q & STATION 125+54.23...
SECTION 20, TOWNSHIP 88 NORTH, RANGE 3 WEST
CIVIL TOWNSHIP GREEN BAY ACQUIRED BY LEE COUNTY

3A Project No.: SVK 13-504

Tract X R

PREPARED BY: CHESTER V. BROWN, POEPPING, STONE, BACH AND ASSOCIATES, INC.
100 SOUTH 54TH ST., P.O. BOX #709, QUINCY, IL, 62306, PH. 217-223-4605

ROADWAY EASEMENT PLAT

PARCEL NO. 5687-R

AQUIRED FROM **B & G FAMILY LIMITED PARTNERSHIP**

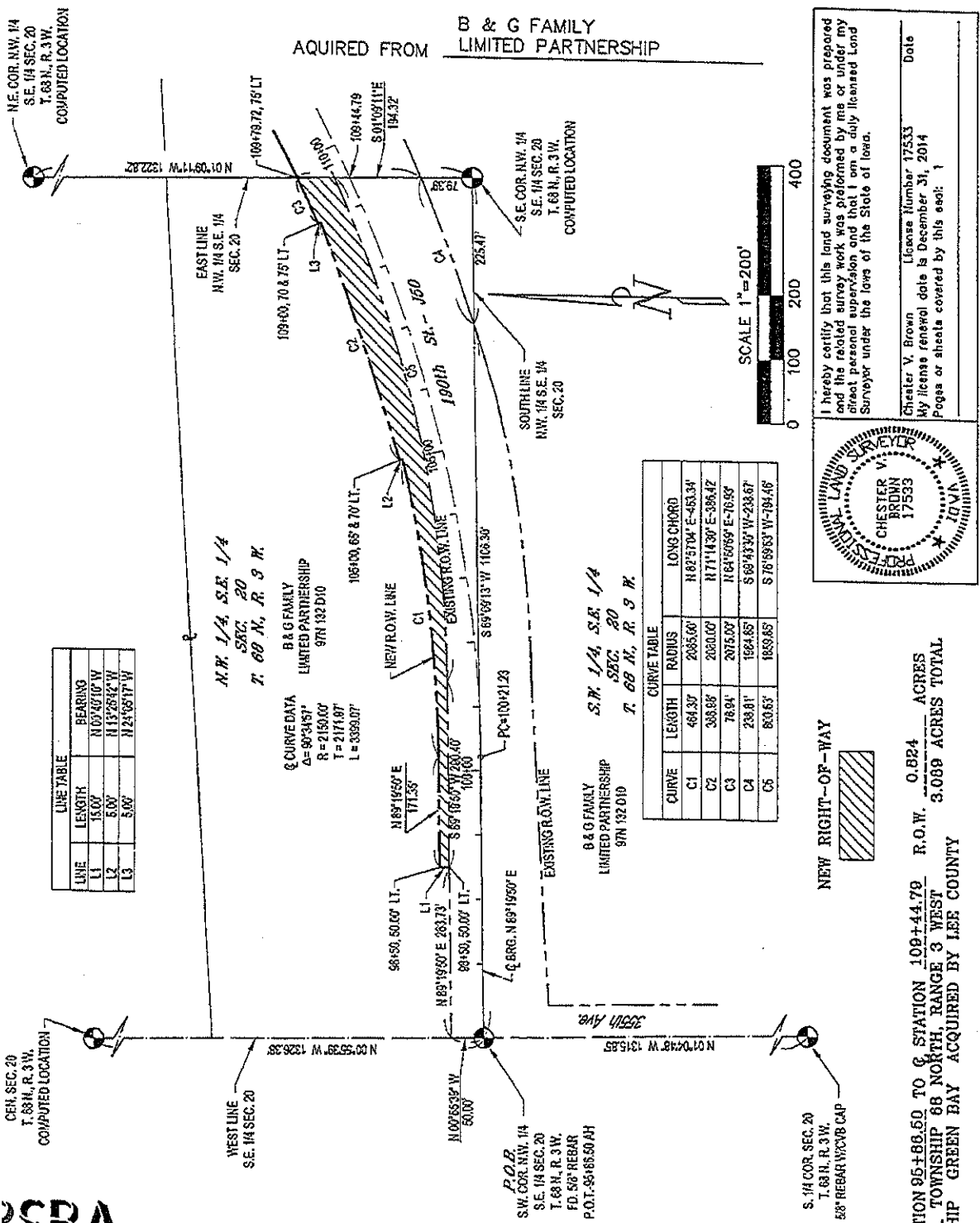

LINE	LENGTH	BEARING
L1	15.00'	N09°47'10" W
L2	5.00'	N13°26'12" W
L3	5.00'	N23°55'17" W

N.W. 1/4, S.E. 1/4
SAC. 20
T. 68 N., R. 3 W.

B & G FAMILY LIMITED PARTNERSHIP
97N 132.010

Q CURVE DATA
Δ = 90°3457'
R = 2150.00'
T = 2171.87'
L = 3390.07'

S.W. 1/4, S.E. 1/4
SAC. 20
T. 68 N., R. 3 W.

B & G FAMILY LIMITED PARTNERSHIP
97N 132.010

CURVE	LENGTH	RADIUS	LONG. CHORD
C1	484.30'	2085.60'	N82°57'04" E-483.34'
C2	388.89'	2080.00'	N71°14'30" E-384.42'
C3	78.94'	2075.00'	N64°50'59" E-76.93'
C4	238.81'	1624.85'	S68°43'37" W-238.67'
C5	80.85'	1889.85'	S76°58'53" W-79.46'

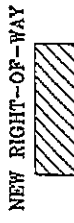

FROM **Q STATION 95+89.60 TO Q STATION 109+44.79** R.O.W. **0.824** ACRES
SECTION 20, TOWNSHIP 68 NORTH, RANGE 3 WEST
CIVIL TOWNSHIP GREEN BAY ACQUIRED BY LEE COUNTY

A Project No.: SVK 13-804



POEPPING, STONE, BACH & ASSOCIATES, INC.
ARCHITECTS ENGINEERS PLANNERS SURVEYORS

100 SOUTH 54TH ST., QUINCY, ILLINOIS 62306
3523 MAIN ST., KEOKUK, IOWA 52240
801 BROADWAY, HANNIBAL, MISSOURI 63401
217-223-4605 319-524-8730 636-406-0541

Tract XI 5

PREPARED BY: CHESTER V. BROWN, POEPPING, STONE, BACH AND ASSOCIATES, INC.
100 SOUTH 54TH ST., P.O. BOX #709, QUINCY, IL, 62306, PH. 217-223-4605

ROADWAY EASEMENT PLAT

PARCEL NO. 5687-S

ACQUIRED FROM B & G FAMILY LIMITED PARTNERSHIP

N.E. COR. NW. 1/4
S.E. 1/4 SEC. 20
T. 68 N., R. 3 W.
COMPUTED LOCATION

N.E. COR. SW. 1/4
S.E. 1/4 SEC. 20
T. 68 N., R. 3 W.
COMPUTED LOCATION

N.W. COR. SW. 1/4
S.E. 1/4 SEC. 20
T. 68 N., R. 3 W.
COMPUTED LOCATION

S. 1/4 COR. SEC. 20
T. 68 N., R. 3 W.
S&S REBAR W/C/B CAP

WEST LINE
S.E. 1/4 SEC. 20

WEST LINE
S.E. 1/4 SEC. 20

WEST LINE
S.E. 1/4 SEC. 20

WEST LINE
S.E. 1/4 SEC. 20

WEST LINE
S.E. 1/4 SEC. 20

WEST LINE
S.E. 1/4 SEC. 20

WEST LINE
S.E. 1/4 SEC. 20

WEST LINE
S.E. 1/4 SEC. 20

WEST LINE
S.E. 1/4 SEC. 20

WEST LINE
S.E. 1/4 SEC. 20

WEST LINE
S.E. 1/4 SEC. 20

WEST LINE
S.E. 1/4 SEC. 20

WEST LINE
S.E. 1/4 SEC. 20

WEST LINE
S.E. 1/4 SEC. 20

WEST LINE
S.E. 1/4 SEC. 20

WEST LINE
S.E. 1/4 SEC. 20

N.W. 1/4, S.E. 1/4
SEC. 20
T. 68 N., R. 3 W.

CURVE	LENGTH	RADIUS	LONG CHORD
C1	9.22	1984.83	S73°16'17" W-9.22
C2	47.28	1930.83	S77°07'05" W-47.28
C3	521.51	2250.00	S82°41'25" W-520.34
C4	400.60	1933.83	N83°33'52" W-399.62

Q CURVE DATA
A=90°24'57"
R=2150.00'
Y=2171.97'
L=3399.07'

B & G FAMILY
LIMITED PARTNERSHIP
97N 132D10

P.O.B.
N.W. COR. SW. 1/4
S.E. 1/4 SEC. 20
T. 68 N., R. 3 W.
FD 5&S REBAR
P.O.T. 56°48'59" AH

Q BRG. N 89°19'50" E

N 01°04'48" W
1000.00'

N 87°03'21" E 504.24'

S 89°19'50" W 434.13'

96°36.36, 100.00 RT.

EXISTING ROW LINE

EXISTING ROW LINE

EXISTING ROW LINE

EXISTING ROW LINE

EXISTING ROW LINE

EXISTING ROW LINE

EXISTING ROW LINE

EXISTING ROW LINE

EXISTING ROW LINE

EXISTING ROW LINE

EXISTING ROW LINE

EXISTING ROW LINE

EXISTING ROW LINE

EXISTING ROW LINE

EXISTING ROW LINE

EXISTING ROW LINE

EXISTING ROW LINE

EXISTING ROW LINE

EXISTING ROW LINE

EXISTING ROW LINE

EXISTING ROW LINE

EXISTING ROW LINE

NORTHLINE
S.W. 1/4, S.E. 1/4
SEC. 20

PC=100+21.23
N 63°09'13" E 106.30'

109+10

106+73.01, 92.15 RT.

104+17

105+00

104+17

103+50

103+00

102+50

102+00

101+50

101+00

100+50

100+00

100+00

100+00

100+00

100+00

100+00

100+00

100+00

100+00

100+00

100+00

100+00

100+00

100+00

100+00

100+00

100+00

100+00

100+00

100+00

100+00

100+00

100+00

100+00

100+00

100+00

100+00

100+00

100+00

100+00

100+00

100+00

100+00

100+00

100+00

100+00

100+00

100+00

100+00

100+00

100+00

100+00

100+00

100+00

100+00

100+00

100+00

100+00

100+00

100+00

100+00

100+00

100+00

100+00

100+00

100+00

100+00

100+00

100+00

100+00

100+00

100+00

100+00

100+00

100+00

100+00

100+00

100+00

100+00

100+00

100+00

100+00

100+00

100+00

100+00

100+00

100+00

100+00

100+00

100+00

100+00

100+00

100+00

100+00

100+00

100+00

100+00

100+00

100+00

100+00

100+00

100+00

100+00

100+00

100+00

100+00

EAST LINE
NW. 1/4, SE. 1/4
SEC. 20

EAST LINE
NW. 1/4, SE. 1/4
SEC. 20

EAST LINE
NW. 1/4, SE. 1/4
SEC. 20

EAST LINE
NW. 1/4, SE. 1/4
SEC. 20

EAST LINE
NW. 1/4, SE. 1/4
SEC. 20

EAST LINE
NW. 1/4, SE. 1/4
SEC. 20

EAST LINE
NW. 1/4, SE. 1/4
SEC. 20

EAST LINE
NW. 1/4, SE. 1/4
SEC. 20

EAST LINE
NW. 1/4, SE. 1/4
SEC. 20

EAST LINE
NW. 1/4, SE. 1/4
SEC. 20

EAST LINE
NW. 1/4, SE. 1/4
SEC. 20

EAST LINE
NW. 1/4, SE. 1/4
SEC. 20

EAST LINE
NW. 1/4, SE. 1/4
SEC. 20

EAST LINE
NW. 1/4, SE. 1/4
SEC. 20

EAST LINE
NW. 1/4, SE. 1/4
SEC. 20

EAST LINE
NW. 1/4, SE. 1/4
SEC. 20

EAST LINE
NW. 1/4, SE. 1/4
SEC. 20

EAST LINE
NW. 1/4, SE. 1/4
SEC. 20

EAST LINE
NW. 1/4, SE. 1/4
SEC. 20

EAST LINE
NW. 1/4, SE. 1/4
SEC. 20

EAST LINE
NW. 1/4, SE. 1/4
SEC. 20

EAST LINE
NW. 1/4, SE. 1/4
SEC. 20

EAST LINE
NW. 1/4, SE. 1/4
SEC. 20

EAST LINE
NW. 1/4, SE. 1/4
SEC. 20

EAST LINE
NW. 1/4, SE. 1/4
SEC. 20

EAST LINE
NW. 1/4, SE. 1/4
SEC. 20

EAST LINE
NW. 1/4, SE. 1/4
SEC. 20

EAST LINE
NW. 1/4, SE. 1/4
SEC. 20

EAST LINE
NW. 1/4, SE. 1/4
SEC. 20

EAST LINE
NW. 1/4, SE. 1/4
SEC. 20

EAST LINE
NW. 1/4, SE. 1/4
SEC. 20

EAST LINE
NW. 1/4, SE. 1/4
SEC. 20

EAST LINE
NW. 1/4, SE. 1/4
SEC. 20

EAST LINE
NW. 1/4, SE. 1/4
SEC. 20

EAST LINE
NW. 1/4, SE. 1/4
SEC. 20

EAST LINE
NW. 1/4, SE. 1/4
SEC. 20

EAST LINE
NW. 1/4, SE. 1/4
SEC. 20

EAST LINE
NW. 1/4, SE. 1/4
SEC. 20

EAST LINE
NW. 1/4, SE. 1/4
SEC. 20

EAST LINE
NW. 1/4, SE. 1/4
SEC. 20

EAST LINE
NW. 1/4, SE. 1/4
SEC. 20

EAST LINE
NW. 1/4, SE. 1/4
SEC. 20

EAST LINE
NW. 1/4, SE. 1/4
SEC. 20

EAST LINE
NW. 1/4, SE. 1/4
SEC. 20

EAST LINE
NW. 1/4, SE. 1/4
SEC. 20

EAST LINE
NW. 1/4, SE. 1/4
SEC. 20

EAST LINE
NW. 1/4, SE. 1/4
SEC. 20

EAST LINE
NW. 1/4, SE. 1/4
SEC. 20

EAST LINE
NW. 1/4, SE. 1/4
SEC. 20

EAST LINE
NW. 1/4, SE. 1/4
SEC. 20

EAST LINE
NW. 1/4, SE. 1/4
SEC. 20

EAST LINE
NW. 1/4, SE. 1/4
SEC. 20

EAST LINE
NW. 1/4, SE. 1/4
SEC. 20

EAST LINE
NW. 1/4, SE. 1/4
SEC. 20

EAST LINE
NW. 1/4, SE. 1/4
SEC. 20

EAST LINE
NW. 1/4, SE. 1/4
SEC. 20

EAST LINE
NW. 1/4, SE. 1/4
SEC. 20

EAST LINE
NW. 1/4, SE. 1/4
SEC. 20

EAST LINE
NW. 1/4, SE. 1/4
SEC. 20

EAST LINE
NW. 1/4, SE. 1/4
SEC. 20

EAST LINE
NW. 1/4, SE. 1/4
SEC. 20

EAST LINE
NW. 1/4, SE. 1/4
SEC. 20

EAST LINE
NW. 1/4, SE. 1/4
SEC. 20

EAST LINE
NW. 1/4, SE. 1/4
SEC. 20

EAST LINE
NW. 1/4, SE. 1/4
SEC. 20

EAST LINE
NW. 1/4, SE. 1/4
SEC. 20

EAST LINE
NW. 1/4, SE. 1/4
SEC. 20

EAST LINE
NW. 1/4, SE. 1/4
SEC. 20

EAST LINE
NW. 1/4, SE. 1/4
SEC. 20

EAST LINE
NW. 1/4, SE. 1/4
SEC. 20

BEFORE THE LEE COUNTY CONDEMNATION COMMISSION

IN THE MATTER OF THE
CONDEMNATION OF CERTAIN
LANDS IN LEE COUNTY, IOWA

RE: PROJECT NO. RC-CO56(87)-9A-56

ORDER APPOINTING COMPENSATION COMMISSION

NOW on this the 2nd day of February, 2015, the undersigned, Chief Judge of the Eighth Judicial District of the State of Iowa is in receipt of an "Application for Appointment of Commission to Assess Damages" presented on behalf of Lee County, Iowa, by the County Attorney of Lee County, Iowa. The land sought to be condemned is agricultural property and is sought to be condemned for the purposes of a roadway construction, reconstruction and improvement project in Lee County, Iowa. Accordingly, in conformity with Section 6B.4, Code of Iowa, the undersigned has selected by lot, the following named individuals to serve as the compensation commission to assess damages to all property to be taken.

It is hereby ORDERED that the following individuals are named to the compensation commission:

OWNERS OR OPERATORS OF AGRICULTURAL PROPERTY

Name: Dave Houston

Address: 3047 Hwy 16, Wever, IA 52658

Name: Dusty Wellman

Address: 1361 140th Street, Donnellson, IA 52625

FIRST ALTERNATE:

Name: Larry Lang

Address: 1545 180th St., Donnellson, IA 52625

SECOND ALTERNATE

Name: Steve Newberry

Address: 1712 300th St, Argyle, IA 52619

THIRD ALTERNATE

Name: Chris Lindner

Address: 2367 Johnston St. Rd, Keokuk, IA 52632

REAL ESTATE SALES PERSONS OR BROKER

Name: Tony Sargent - Cramer Real Estate

Address: 3806 Main St, Lot 59, Keokuk, IA 52632

Name: Cynthia Otte - KLM Realty

Address: 3331 Country Club Lane, Fort Madison, IA 52627

FIRST ALTERNATE:

Name: Sandy Steffen - Hope Real Estate

Address: 1123 48th Street, Apt. 30, Ft. Madison, IA 52627

SECOND ALTERNATE

Name: Penny Logsdon- Sutlive Realty

Address: 3580 Argyle Road, Keokuk, IA 52632

THIRD ALTERNATE

Name: Daniel Fraise -Fraise Real Estate

Address: 2374 Hwy 2, Donnellson, IA 52625

**PERSONS HAVING KNOWLEDGE OF PROPERTY VALUES BY REASON OF
THEIR OCCUPATIONS**

Name: Matt Morrison – Pilot Grove Bank

Address: 814 Fruit St., Donnellson, IA 52625

Name: Barb Smidt – First Community

Address: 2001 Meadow Lane, Keokuk, IA 52632

FIRST ALTERNATE:

Name: Cindy Roberts – Midwest One

Address: 1726 Ave B, Fort Madison, 52627

SECOND ALTERNATE

Name: Tonya Gaylord – Farmers Savings Bank

Address: 1871 303rd Ave, Fort Madison, IA 52627

THIRD ALTERNATE

Name: Linda Mullen – KSB

Address: 2018 Grand Ave, Keokuk, IA 52632

Appointed as chairperson of the above-constituted compensation commission is Cynthia Otte
– KLM Realty. In the event that this person is unable to serve, Matt Morrison – Pilot Grove
Bank is appointed as alternate chairperson.

The above-constituted compensation commission shall consist of six (6) persons.

In the event that a person named to the compensation commission is unwilling or
unable to serve, an alternate is appointed in the order in which named.

All members of the compensation commission shall qualify by filing an oath that they will do the best of their ability faithfully and impartially assess said damages and make written report to the Sheriff.

No member of the compensation commission selected shall possess any interest in the proceeding which would cause such person to render a biased decision.

Filed in the Office of the Chief Judge of the Eighth Judicial District on the date above given.



Mary Ann Brown
Chief Judge, 8th Judicial District

A copy filed of record in the Office of the Sheriff of Lee County on this the _____ day of February, 2015.

James A. Sholl
Sheriff of Lee County, Iowa

Hartzog, Anna [SOS]

From: Reynolds, Leslie [reynolds@sso.org]
Sent: Friday, January 09, 2015 1:27 PM
To: Hartzog, Anna [SOS]
Cc: Dodd, Stacy
Subject: RE: Correspondence from Paul Pate Secretary of State Iowa

Hi Secretary Pate,

I'm delighted to know that you are eager to become more involved with NASS!

I look forward to seeing you at the NASS Winter Conference next month, here in DC at the JW Marriott! We will start that conference with a New Secretary Orientation and Reception on Tuesday, February 10, 2015.

We have already listed you on the rosters of committees over which your office has jurisdiction: Elections, Voter Participation and Business Services.

However, there are other committees in which you may be interested including Awards, International Relations, Corporate Affiliate Advisory. You will have the opportunity to sign up for those committees at the conference.

I look forward to seeing you next month. If you have any questions or would like to speak before the conference, I am available anytime for a call. My direct line is 202-624-3526.

All the best,
Leslie

Leslie Reynolds
Executive Director
National Association of Secretaries of State
444 N. Capitol Street, N.W.
Suite 401
Washington, DC 20001
202-624-3525
www.nass.org

From: Hartzog, Anna [SOS] [<mailto:Anna.Hartzog@sos.iowa.gov>]
Sent: Thursday, January 08, 2015 11:56 AM
To: Reynolds, Leslie
Subject: Correspondence from Paul Pate Secretary of State Iowa

I am looking forward to becoming active in NASS as Iowa's Secretary of State. My previous service as Iowa's Secretary as State and as an emeritus member of NASS was very productive.

After reviewing the NASS website I can see the many crucial areas NASS is leading on. I respectfully offer my service and skills. When should I speak to you about I can become more involved?

Respectfully,

Paul Pate

Iowa Secretary of State

Email secured by Check Point